

MASTER LEDtube EM/ Mains T8

Master LEDTube 1200 mm 18W 865 T8 I W

The Philips MASTER LEDtube integrates a LED light source into a traditional fluorescent form factor. Its unique design creates a perfectly uniform visual appearance which cannot be distinguished from traditional fluorescent. For those that are looking for value for money within limited budget and re-lamping efforts for better light effect and lifetime.

Product data

General Information	
Cap-Base	G13 [Medium Bi-Pin Fluorescent]
Main Application	Industrial
Nominal Lifetime (Nom)	40000 h
Switching Cycle	50000X
B50L70	40000 h

Light Technical	
Color Code	865 [CCT of 6500K]
Beam Angle (Nom)	160 °
Luminous Flux (Nom)	2100 lm
Luminous Flux (Rated) (Nom)	2100 lm
Rated Beam Angle	160 °
Correlated Color Temperature (Nom)	6500 K
Color Consistency	<6
Color Rendering Index (Nom)	82
LLMF At End Of Nominal Lifetime (Nom)	70 %

Operating and Electrical	
Input Frequency	50 to 60 Hz

Power (Rated) (Nom)	18 W
Lamp Current (Nom)	74 mA
Starting Time (Nom)	0.5 s
Warm Up Time to 60% Light (Nom)	instant full light s
Power Factor (Nom)	0.92
Voltage (Nom)	100-240 V

Temperature	
T-Ambient (Max)	45 °C
T-Ambient (Min)	-20 °C
T-Storage (Max)	65 °C
T-Storage (Min)	-40 °C
T-Case Maximum (Nom)	70 °C

Controls and Dimming	
Dimmable	No

Mechanical and Housing	
Product Length	1200 mm

MASTER LEDtube EM/Mains T8

Approval and Application

Energy Efficiency Label (EEL)	A+
Energy Saving Product	Yes
Suitable For Accent Lighting	No
Approval Marks	CE marking RoHS compliance KEMA Keur certificate
Energy Consumption kWh/1000 h	18 kWh

Product Data

Full product code	871869652406000
-------------------	-----------------

Order product name	Master LEDTube 1200 mm 18W 865 T8 I W
EAN/UPC - Product	8718696524060
Order code	929001187812
Numerator - Quantity Per Pack	1
Numerator - Packs per outer box	10
Material Nr. (12NC)	929001187812
Net Weight (Piece)	0.230 kg

Warnings and Safety

- NOTES: The overall energy efficiency and light distribution of any installation that uses these lamps are determined by the design of the installation.

Dimensional drawing

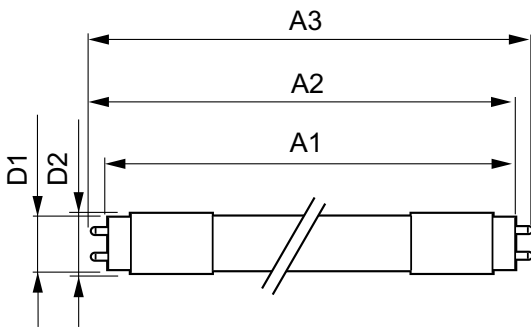

LEDtube 1200mm 18W/865 T8 I W

Product	D1	D2	A1	A2	A3
Master LEDTube 1200 mm 18W 865 T8 I W	25.6 mm	27.8 mm	1198.1 mm	1205.2 mm	1212.3 mm

Photometric data

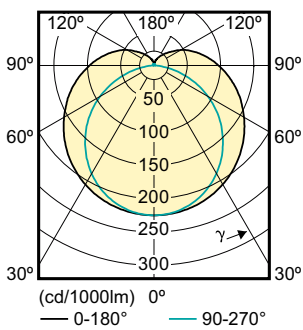

LEDtube 1200mm 18 W T8 I W

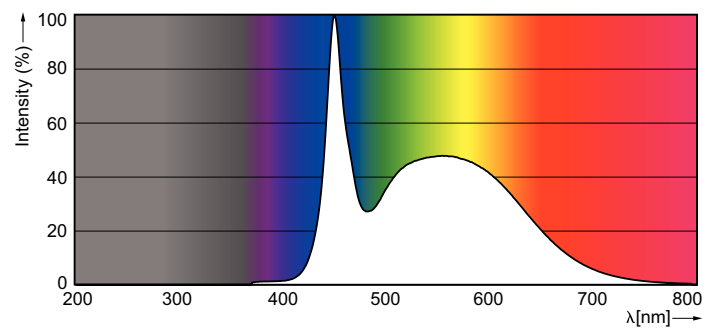

LEDtube 1200mm 18 W /865 T8 I W

MASTER LEDtube EM/Mains T8

Lifetime

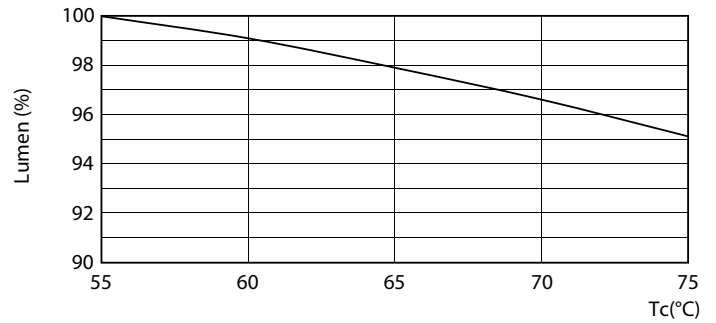
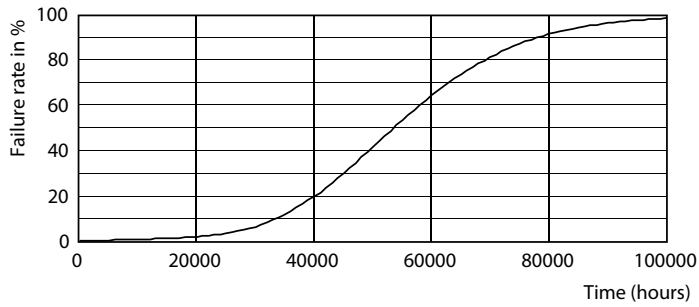

LEDTube 1200 mm 18W 840 T8 I W

LEDTube 1200 mm 18W 840 T8 I W LumenVsTc

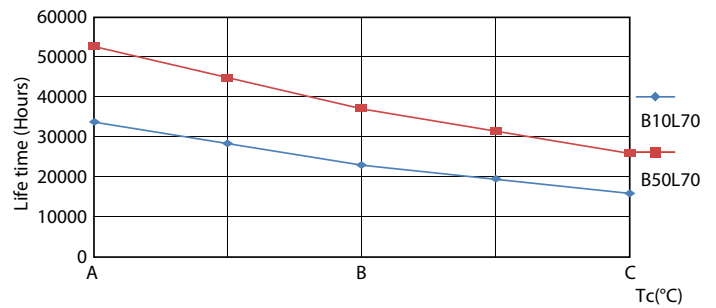
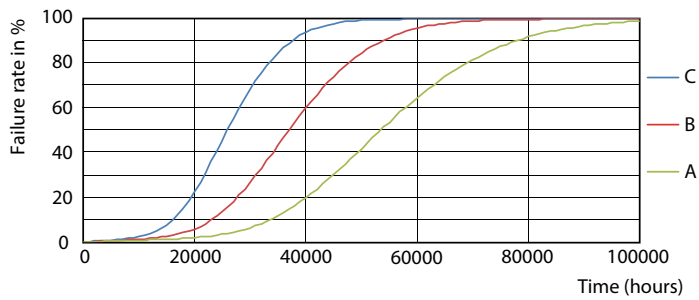

LEDTube 1200 mm 18W 840 T8 I W FailureRate

LEDTube 1200 mm 18W 840 T8 I W LifetimeVsTc

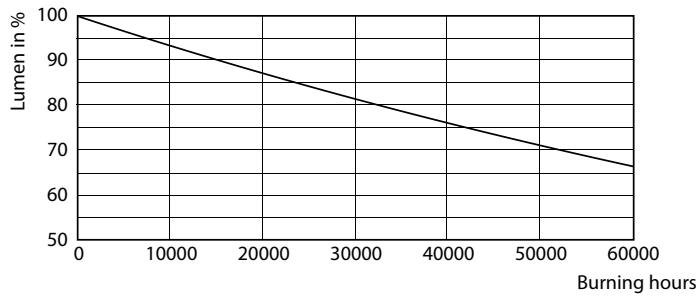

LEDTube 1200 mm 18W 840 T8 I W

MASTER LEDtube EM/Mains T8

